

year in review

2016

# IAPMO INDIA PUBLICATIONS



To order copies and also for package & bulk orders/all details,  
please write to [swathi.saralaya@iapmo.org](mailto:swathi.saralaya@iapmo.org) or send us your request at  
IAPMO India No. 22, 12th B Main, HAL 2nd Stage, Indiranagar,  
Bengaluru – 560008, Telephone: 91-80-30714504



## INTERNATIONAL ASSOCIATION OF PLUMBING AND MECHANICAL OFFICIALS

The International Association of Plumbing and Mechanical Officials (IAPMO) was founded May 17, 1926, with the mandate "to advance the latest and most improved methods of sanitation; to promote the welfare of and harmony between the owner, the builder, and the craftsman; to accomplish a uniformity in the application of the provisions of the ordinances; and to promulgate the mutual benefit of the members."

The IAPMO Group focuses its comprehensive capabilities in the technical aspects of the plumbing and mechanical industries through its extensive knowledge base, which includes regulators, professional contractors and manufacturers. Comprised additionally of six different business units, The IAPMO Group is truly the one-stop shop for all plumbing and mechanical code and product compliance.



## INTERNATIONAL ASSOCIATION OF PLUMBING AND MECHANICAL OFFICIALS INDIA

The International Association of Plumbing and Mechanical Officials (IAPMO) has a strong cooperative presence in the nation of India and partnered with the Indian Plumbing Association (IPA) to develop a uniform plumbing code for the nation.

The registrar of companies of India approved the establishment of IAPMO Plumbing Codes and Standards India Private Limited, to be known as IAPMO – India. IAPMO and the IPA, both members of the World Plumbing Council (WPC), agreed upon a comprehensive plan to work together to establish a model code of plumbing installation and maintenance for all of India, the Uniform Plumbing Code – India. The IPA Code committee worked with IAPMO staff in creating a document that recognized and utilized proven international concepts, always taking into consideration the proven plumbing practices within India.



## THE INDIAN PLUMBING ASSOCIATION

The Indian Plumbing Association (IPA), established in 1993, is the apex body of plumbing professionals in the country. Set up with an objective to promote advancements in plumbing and the building service industry, IPA has successfully created a forum for exchange of ideas and dissemination of information among its members. As a member of the World Plumbing Council, it encourages its members to achieve and maintain high standards of workmanship.

IPA's membership includes architects, builders, plumbing consultants, plumbing contractors, plumbing product manufacturers, traders and planners. IPA also conducts conferences and exhibitions throughout India and publishes the monthly magazine *Indian Plumbing Today*. The idea is to make local plumbing professionals aware of issues, problems and prospects in the industry. IPA has succeeded in creating awareness about the need for safe plumbing, and is now ready to assist the Indian professionals with improving their skills and expertise.



# GP Russ Chaney

IAPMO Chief Executive Officer

**W**e are absolutely delighted to provide this annual year in review for 2016 as our IAPMO India staff did a fantastic job providing much-needed educational services, setting a record for corporate growth in this region of our world. I have a high degree of respect and admiration for the IAPMO India staff who are on the front lines of IAPMO's efforts to provide the needed education and technical support to continue to assist in the enhancement of the industry with the ultimate goal of protecting the health and safety of the nation's citizens through effective codes and standards.

It is certainly a pleasure to find ourselves at the end of another exciting year. As we look at the year in review for IAPMO India, we remain encouraged by the continued progression and impact potential that can be accomplished through the dedicated efforts of our staff and treasured partners.

Since its inception in 2007, IAPMO India has worked extensively to lay the groundwork necessary to assist in the commitment to public health and safety through effective codes, standards, and training programs. The relationships made through the development of codes and training for the plumbing and mechanical industry has offered IAPMO India the opportunity to focus on the delivery of elite services for the industry, and India at large. As much as ever before, we take our hats off to the Indian Plumbing Association (IPA) for its unprecedented dedication and passion that continues to keep India at the forefront of the industry and around the globe. We look forward to working with the new leadership of IPA, and are very encouraged by the commitment and dedication of the National Executive Committee and its election of Gurmit Singh Arora as the incoming President. It is with great acknowledgement that we also honor Sudhakaran Nair, IPA President for more than 13 years, as the foundation of the relationship formed more than a decade ago, a direct result of his supported commitment and willingness to work closely with IAPMO and the IAPMO India team.

Highlighting this strong partnership over the past decade, we have developed and published *Uniform Illustrated Plumbing Code – India*, *Uniform Mechanical Code – India*, *Green Plumbing Code Supplement – India*, *Green Mechanical Code Supplement – India* for the Indian plumbing and mechanical industries, and will continue to dedicate our efforts to assist in the standardization of the industry to protect the health and safety of the nation. On behalf of all my colleagues and on my personal behalf, I sincerely thank all of the dedicated individuals who were involved in our pursuit to improve plumbing standards in India and I look forward to many more years of our rewarding partnerships.





# Gurmit Singh Arora

President of Indian Plumbing Association

Since I have taken over as President of IPA recently, this is my first message to you. Our partnership with IAPMO dates back to our agreements dtd Nov, 2007.

We cherish this relationship & do hope it grows in the years to come. The codes published & revised today including the *Uniform Illustrated Plumbing Code of India (UIPCI)*, *The Solar Code*, *The Uniform Swimming Pool Code*, *The Water Efficient Products India Guide*, the *Green Plumbers Code Supplement* which are all testimony to our strong partnership, belief & bond that both IAPMO & IPA so very well share together. We are proud of having been associated with IAPMO & do look forward to a more fruitful relationship in the near future. Since the *Uniform Plumbing Code*, now *UIPCI* in its new avatar has been revised & published in 2008, 2011 & 2014, we will not revise the *UIPCI* again. Having gone through 3 revisions, the code is now quite comprehensive & updated with the latest technologies & product specifications. Any changes in plumbing technologies will be addressed by adding addendums to the same.

The need for government recognition of our codes still needs to be addressed. Even though codes in India are recommendatory it is still important for IPA & IAPMO to get recognition of its codes by both State as well as Central Governments. There lacks a gap within the NBC & the UIPC & hence UIPC also needs to be recognized & adopted by government.

IPA is now a body of approx 2600 professionals with 15 chapters spanning across India. Our target is to grow 20% P.A. & spread the message of correct plumbing practices & sustainable plumbing. IPA will venture in installing many more Plumbing Laboratories at institutions which desire to show case current & correct live models in plumbing both to faculty & students. One such laboratory is already being installed at CV Raman College of Engineering, Bhubaneswar.

We are also proud to be part of "The Build Fare Alliance" in partnership with Acrex, FSIE, Fentsterbrau Frontale & GlassPro. The synergy in building services will help visitors to visit all the 5 exhibitions in one venue, at the India Exposition Mart Ltd (IEM), Greater Noida in between February, 23rd to 25th 2017.

We will be celebrating World Plumbing Day on the 11th of March in all 15 chapters simultaneously. Seminars and Painting Competitions have been planed across all IPA chapters. The 23rd India Plumbing Conference will also be held in Chennai this year on the 22nd & 23rd Sept, 2017 & I hope to welcome the plumbing community in Chennai.

We perceive a great partnership with IAPMO & would like to thank all IAPMO staff for their unstinted & ever helpful support.





# Megan Lehtonen

Senior VP of International Business Development

It has been another exciting year for IAPMO India, and for the entire industry, the world over. IAPMO's exponential growth in developing markets is the result of the progressive and innovative conceptualism of this organization's leadership from almost a century ago.

When we focus on global growth, emphasis on the strategic and proactive vision that came to fruition nearly 20 years ago is again thrust into the spotlight. I have been fortunate enough to hear many times over, across the globe, that the foresight and vision of this organization is unprecedented and has strongly planted the IAPMO seed in developing markets to assist in this great industry's growth. The biggest joy of this statement is that the heart of this mission was with a philanthropic focus — to work to improve on the human condition by fostering the basic human right of safe access to clean water and sanitation.

The IAPMO India business unit, created nearly 10 years ago, has seen its growth double annually for the past few years under the steady watch of Managing Director Neeta Sharma, and through strong partnerships, with the IPA and IGBC leading the charge. This consistent increase is the result of the continuing training programs originally implemented at the grass-roots level a decade ago, and the introduction and capitalization of state-funded programs as the country moves to focus on the upskilling of youth as a top priority. IAPMO India has trained 800 students in the Kerala state-run program alone this year, at more than 30 training centers, with additional programs in the pipeline. Stuart Henry, World Plumbing Council Secretariat, reminded me of a great concept earlier this year: "Skills in the land equal gold in the hands." It's a philosophy on which we will continue to

focus and continue to build training programs and workshops to upskill the huge workforce within India.

The decade-long partnership with the Indian Plumbing Association has strongly positioned the industry to bring about an unparalleled self-regulated cultural advancement. As a business unit, this has been IAPMO India's strongest year to date since its inception in 2007. IAPMO India has been building on the value of training and education, together with the overall market's understanding of the need for certification. With this progress, India continues to grow into a practical solution for clients in the Asian region. We look forward to the first-ever MESSE ISH: India show, powered by IPA, in early 2017, showcasing industry services and the potential for further growth in this region.

Another exciting development this year is the creation and expansion of the Water Quality Association India's Certification program. IAPMO India will assist the WQAI with all testing and certification needs, and is proud to have the first Purity Seal recently awarded! This program, along with other future certification programs, will continue to expand the IAPMO India portfolio. The mechanical program has gained major momentum this year thanks to Dr. Abdul Matheen's diligence and our great partner ISHRAE offering training programs and highlighting the use of the UMC-I.

It is with great honor and elation that this work, decades in the making, has resulted in another exciting announcement: The creation of an IAPMO foundation to fill the niche throughout the Water Sanitation and Hygiene (WASH) sector. This initiative, building on the philanthropic projects in which IAPMO has invested, has resulted in the creation of The



International Water, Sanitation and Hygiene Foundation (IWSH). IWSH is a progressive and vast vehicle to further The IAPMO Group's humanitarian efforts, created to serve as the necessary bridge for the international water, sanitation, and hygiene community. The foundation has a specific focus on the role of the plumbing industry in community collaborations and educational exchange, and is in a critical position to capitalize on the vast industry network and expertise, ensuring the health and safety of the global community by increasing access to safe drinking water and sanitation systems.

According to the 2016 United Nations Sustainable Development Goals, 2.4 billion people lack access to such basic sanitation services as toilets or latrines, and water scarcity affects more than 40 percent of the global population; this number is projected to rise.

IWSH will align IAPMO's existing projects throughout the world with those of government, industry, and communities to ensure water systems are safe and sustainable; building a bridge within the WASH community, expanding the industry, and impacting thousands of lives through enhanced systems and education.

Along with numerous projects and targets focused on the foundation's mission, including expanding training programs to upskill the workforce in developing countries and creating sustainable communities, IWSH will utilize our vast network of experts and resources to rebuild and enhance facilities and upgrade school and public washroom and handwashing stations. The preliminary target and focus of the foundation is the ongoing work conducted through the innovative Community Plumbing Challenge (CPC). Just last year, the first "CPC: Nashik" was completed, enhancing the washroom facilities of School 125 in Nashik, India. This competition featured teams from Australia, Basque Country, India, and the United States.

These global teams worked together to build a new sanitation facility for Mukti Dham School No. 125, home to 400 students between the ages of 7 and 15. The school now has 25 working taps (up from four before) and hand wash drainage, two taps in toilet areas (none before), improved ventilation, better water pressure, and

higher water tank storage capacity. The CPC was again a success this year as "CPC: Diepsloot" visited South Africa. On the initial trip in March 2016, the team, with partner Healthabitat, replaced 14 toilets — improving access to more than 1,250 people, and enabling 56,000 liters of water to be saved on a daily basis.

The high-profile project was supported by numerous in-country partners — WASSUP (Water, Amenities, Sanitation Services Upgrade Programme), DACN (Diepsloot Arts & Culture Network) — in collaboration with Healthabitat Sanitation Studio and facilitated in South Africa by Sticky Situations, along with event partners Autodesk and the Wot-If Trust. U.S. Consul General Rowan and other international dignitaries supported the project through multiple visits and continue to carry on the positive message of the impact the CPC will continue to have.

The work has only just begun, and we look forward to future projects and updates as the foundation continues to build its network and respond to the long list of projects and events that will result in exponential impact. The IWSH Foundation will support existing initiatives already under way with a heavy focus within India, and in Indonesia, Jordan, Nepal, and South Africa, and will continue to identify nations where improvements in the governance of their water and sanitation services would lead to positive outcomes associated with clean water and sanitation access.

Please be sure to visit [www.IWSH.org](http://www.IWSH.org) to view the video highlights of the recent CPC:Diepsloot, to get involved, be part of the movement, and for more information on what is planned for 2017!

The world continues to get smaller on a daily basis, as technology, connectivity, and global capabilities deliver solutions we wouldn't have dreamt of even a decade ago. And as necessity is often the mother of invention, it is our goal to continue to stay in front of this curve and work diligently to find and deliver the best services to our customers, and create the most impactful programs through our philanthropic efforts, in every corner of this energizing world.

# IWSH.org

## DRIVING DEVELOPMENT FOR CHANGE

IWSH supports the international Water, Sanitation and Hygiene sector by emphasizing plumbing's role in providing safe, sustainable water systems and community-based educational programs.

In support of the UN Sustainable Development Goals, we collaborate with our sponsors to help develop and train local, skilled workforces with the knowledge to build, install and maintain systems using readily available goods and tools.

## JOIN US TODAY!



# INDIA

Collaborative design and construction of new handwashing and toilet facilities, and development of plumbing skills training programs at Municipal Schools.

# NEPAL



Renovation of sanitation systems for schools in earthquake-affected areas.

**“ I set out to assist local children that needed help, and feel I achieved this by working with the other teams. It was an extremely rewarding experience and I loved every second of it. ”**

TEAM MEMBER, COMMUNITY PLUMBING CHALLENGE 2015: NASHIK, INDIA





# Neeta Sharma

Managing Director

**D**uring the year, there were many enquiries from education institutes for our PEEP, *Plumbing Education to Employment Programme*, and MEEP, *Mechanical Education to Employment Programme*, including customization of programme to their individual needs.

**State Skill Development Project**, an ambitious project of Kerala, aims to sensitize and equip its young population with skills in various sectors and alleviate the unemployment problem in the state, complementing NSDC mission to meet the demand for increased skilled manpower to sustain the industrial growth and thereby the nation's economic growth. The project combines both preventive (**Additional Skill Acquisition Programme — ASAP**) and curative (**Additional Skill Enhancement Programme**) approaches.

IAPMO India, after signing an agreement with the government of Kerala to develop competent manpower in the plumbing sector to offer skill-oriented courses in plumbing, continued to more than 30 centers spread across various districts of the state. Over the past three years, more than 1,600 students have benefited from this training through Skill Development Centers spread across all districts of Kerala. The government of Kerala recognizes these centers. Interested students got good placements within the State and in adjoining States. This brought in an affiliation with the Indian Plumbing Skill Council (IPSC), where the Plumbing Assistant Programme was mapped to their NOSs. This will surely fill a huge gap of skilled manpower in the construction industry. Efforts are also being made for approval under the PMKVY Project, the Ministry of Skill Development and Entrepreneurship, or any other state skill project to take for skilling of manpower.

A better way of utilizing CSR funds is to use them for training the unemployed youth and upskilling professionals for the benefit of the industry and the professionals. One such project of Federal Bank is presently running our programmes on plumbing and mechanical in Cochin, which is expanding across the country.

Our association with ISHRAE, to mutually promote education programmes by jointly conducting them in various Centers of Excellence of ISHRAE, will be an effort to bridge the gap of demand of trained professionals.

Certification is an ultimate tool/ indicator of acceptance of any quality standard. Our continued effort of getting as many manufacturers to accept our certification scheme as possible for the products that are not covered under Mandatory Certification by any guidelines or notifications saw an incredible increase. Through discussions with our stakeholders, various issues were created out. With the support of the whole team, we are sure to take a big leap in this area. With more global and Indian manufacturers now listed, there is a good-size sample of efficient products tested for performance and efficiency.

The industry has come to understand the benefits of seeking IAPMO certification for obvious reasons, as it opens doors for export to the global market. This facilitates local manufacturers to become vendors for the international market. Our partnership with the Water Quality Association India (WQA I) as the certification body to offer WQA I's **Seal of Purity** on a product as per WQA INDIA microbiological standard— **WQA INDIA protocol: IP 100; NSF certification** and relevant NSF certifications was initiated during this year.

As a move forward to operate as a certification body, we plunged into RMC plant certification. As a first step we took approval for RMCPSC, Ready Mix Concrete Plant Certification Scheme, by QCI. Although RMCPSC is mandatory only in two states — Maharashtra and Karnataka — it is likely to spread across the country to all quality-conscious developers & contractors.

I would like to emphasize the need for all stakeholders in construction industry to support a sustainable environment by seeking third-party-certified products, third-party inspections of projects (water and energy audits) and skilled and certified personnel. IAPMO India will strive to contribute to this achievement by offering high-quality, professional services in these areas.





# Dr. Abdul Matheen

Director Mechanical

“Investing in education and skills for women and men to help economies achieve dynamic growth with quality jobs is a pressing priority throughout the globe.”

## **MATCHING SKILLS AND LABOR MARKET NEEDS BUILDING SOCIAL PARTNERSHIPS FOR BETTER SKILLS AND BETTER JOBS:**

Skills are a critical asset for individuals, businesses and societies. The importance of skills is even more pronounced in a dynamic, globalized world. Building basic skills early on, enhancing them during your working life, and ensuring that they are recognized and used by employers is a challenge. Another concern, matching skills and jobs, has become a high-priority policy concern. Skills mismatches occur when workers have either fewer or more skills than jobs require. Some mismatch is inevitable, as the labor market involves complex decisions by employers and workers and depends on many external factors. But high and persistent skills mismatch is costly for employers, workers and society at large. Skills mismatch has become more prominent in the global economic crisis. However, it is primarily a structural issue, and as such existed prior to the recent global economic slowdown. For the same reason, contrary to what some commentators believe, current record-high unemployment rates cannot be attributed to skills mismatch. Indeed, there is no evidence that skill levels have collapsed during the crisis.

Skills and knowledge are the engines of economic growth and social development in any country. IAPMO India has both the skill and the knowledge to offer the Indian mechanical HVAC-R Industry. The establishment of skills development programs and continuing education systems will provide an institutional mechanism to facilitate greater industry participation and better link skill development

with the country's employment demands. The shortage of skilled workers across many industries is emerging as a significant and complex challenge to India's growth and future.

IAPMO India has been playing a pivotal role in nation building by introducing the cutting-edge concept of a complete "education-to-employment" cycle such as MEEP (Mechanical Education to Employment Program) training to the university youths at the entry level in order to tackle the impending shortage of knowledge workers. This strategy will allow fresh graduates or diploma holders to have dual certification. This will mitigate the existing shortfall of trained professionals at the entry level for which companies today have spent a lot. IAPMO India has firmly installed plumbing education systems and is now ready to offer mechanical education systems to Indian citizens. MEEP graduates of the multilevel education programs will be given the option of obtaining professionally qualified certifications with the following credentials:

- **Mechanical HVAC-R System Design (MSD) Program**

The objective of this program is to prepare and educate mechanical system designs such as mechanical heating ventilation and air-conditioning system design and installation specifics with a code-based education program for training on the latest developments in the related codes and standards applicable to the mechanical HVAC-R domain, keeping in mind the present and future global industrial requirements so that skilled manpower of the country will be able to compete in the global market.



- **Mechanical Supervisors Program [MSP]**  
This program's objective is to train and equip mechanical installation, commissioning and O & M supervisors with code-based education programs for training on the latest knowledge in the related codes and standards applicable to the mechanical HVAC-R trade, keeping in view of the present and future global industrial requirement.
- **Mechanical Technicians Program [MTP]**  
This program's objective is to train and equip mechanical technicians with a code-based education program for imparting training on the latest knowledge in the related codes and standards applicable to the mechanical trade, keeping in view of the present and future global industrial requirements, so that semi-skilled/skilled manpower of the country will be able to compete in the global market.

#### **MEEP Benefits-**

- Recognition to international body
- Industry-Institutional interactions
- World-class mechanical-HVAC-R education and training
- Better mechanical installations, ensuring energy conservation,
- Enhanced IAQ, safety of public and structures and reduced maintenance
- Energy-efficient installations, increased efficiency and productivity, better reputation

*“IAPMO India invites institutions, universities, state and central Government ministries and organizations to associate with IAPMO India for effective implementation of Job oriented, skills & educational programs, pan India”.*

- **SHORT TERM HVAC-R TECHNICIANS PROGRAMS:**
  - 1) Certificate Course in Basic Refrigeration & Air Conditioning.
  - 2) Certificate Course in Repair & Maintenance of Refrigerators & Deep Freezers.
  - 3) Certificate Course in Repair & Maintenance of Water Coolers & Bottle Coolers.
  - 4) Certificate Course in Repair & Maintenance of Window & Split Air Conditioners.
  - 5) Certificate Course in Repair & Maintenance of Car Air-conditioning Unit.
  - 6) Certificate Course in Servicing & Maintenance of Central Air Conditioning Plant.
  - 7) Certificate Course in Duct Design Installation and Fabrication.
  - 8) Certificate Course in Mechanical HVAC-R Installation, Testing and Commissioning Technicians.
  - 9) Certificate Course in Operation & Maintenance of Chiller Plant.
  - 10) Certificate Course in Mechanical HVAC-R Sales & Service Technicians.



# Charles Gross

Director of India Product Certification

## IAPMO India Product Certification

IAPMO India continues to operate its product certification program based on standard ISO/IEC 17065, "General Requirements for Bodies Operating Product Certification Systems," whereby products are certified to their performance standard and to the products' respective code, such as the 2012 *Uniform Mechanical Plumbing Code - India (UMC-I)* and/or the 2014 *Uniform Illustrated Plumbing Code - India (UIPC-I)*.

## Brief History

In 2007 IAPMO India formally established a successful partnership with the Indian Plumbing Association (IPA) that continues to progress today, but it all began in 2006 when IAPMO initially visited India to discuss partnership with the IPA as well as to initiate plans to jointly develop and publish the first India plumbing code ever, namely the *Uniform Plumbing Code - India (UPC-I)* first published in 2008.

Although the 2008 *UPC-I* was a brand-new code in India, it became better known and used more so each day by varying industries. The 2008 *UPC-I* subsequently underwent update in 2011 and published along with its complementing 2011 *Illustrated Uniform Plumbing Code - India* manual, both of which again underwent update in 2014 to its current combined version, the 2014 *Uniform Illustrated Plumbing Code - India (UIPC-I)*. This latest version was presented for industrial use during the 18th Indian Plumbing Conference in November 2014 in Bengaluru, India. This new 2014 *UIPC-I* supersedes all previous *UPC-I* versions, and is used to evaluate and to certify new products as well as to renew existing certified products. As such, certified products now begin to display the *UIPC-I* mark of conformity which replaces the conventional *UPC-I* mark of conformity previously used.

Additionally, IAPMO India and the IPA continued working together beyond development of the

above codes to structure and initiate plumbing training and educational programs (known as Plumbing Education to Employment Program, or PEEP) with interested academic institutions throughout India for designers, contractors, engineers, and students whose combined graduates now exceed 2000 since the programs' inception in 2009.

Similarly, IAPMO India also began partnerships with other professional organizations such as ISHRAE (Indian Society of Heating, Refrigerating and Air Conditioning Engineers, [www.ishrae.in](http://www.ishrae.in)) to develop the first ever 2012 *Uniform Mechanical Code-India (UMC-I)*, used primarily for design, installation, maintenance and use of heating and cooling products used globally.

## New India Codes and Sustainable Specifications

Complementing development of the first published 2008 *UPC-I*, IAPMO India and the IPA continued joint efforts to subsequently develop other related and complementing industry codes, which are:

- 2011 *Uniform Swimming Pool Code-India (UPSC-I)*,
- 2012 *Uniform Solar Energy Code-India (USEC-I)*,
- 2013 *Water Efficient Products India (WEP-I)*, and
- 2013 *Green Plumbing Code Supplement-India (GPCS-I)*.

All above codes are available on IAPMO India's publications page at [www.iapmoindia.org/Pages/publications.aspx](http://www.iapmoindia.org/Pages/publications.aspx).





## Certification of Sustainable Products

IAPMO India's Classified WEP-I product certification program was introduced to various faucet and sanitary ware manufacturers in 2014 as this program was developed for the efficiency star rating of efficient water consuming products addressed in the WEP-I specification (faucets,

EWCs, shower heads, urinals, etc.) that are not certified to a code such as the *UIPC-I*, *UMC-I* or *USEC-I* codes but that do comply to their pertinent performance test standards such as to an India Standard (IS), or to an International Standard. In addition, these products can also undergo evaluation for a GREEN code rating (GPCS-I/GRIHA/IGBC/LEED) to complement

a Classified WEP-I star rating based on their product's actual water consumptions measured at an IAPMO recognized laboratory. Manufacturers continue to express their appreciation of this new WEP-I/GREEN program since it helps to gain acceptance and distribution of their sustainable water efficient products into their various markets.

IAPMO India's different WEP-I/GREEN star rating marks of conformity used are:

| Mark  | Listing                | Reference(s)   | Required Criteria   |
|---|------------------------|--|---|
|    | WEP-I & UIPC-I         | <i>Uniform Illustrated Plumbing Code – India (UIPC-I) + Water Efficient Products - India (WEP-I)</i>   | Same as <i>UIPC-I</i> listing criteria above plus product must meet respective star rating criteria per the 2013 <i>WEP-I</i> specification.  |
|  | Green WEP-I & UIPC-I   | <i>Uniform Illustrated Plumbing Code – India (UIPC-I) + Water Efficient Products - India (WEP-I) + Green Codes (GPCS-I/ GRIHA/ IGBC/ LEED)</i> | Same as <i>WEP-I</i> & <i>UIPC-I</i> listing criteria above plus product must meet green points criteria in <i>GPCS-I</i> and/ or <i>GRIHA</i> and/ or <i>IGBC</i> and/ or <i>LEED</i> .  |
|  | Green UIPC-I           | <i>Uniform Illustrated Plumbing Code – India (UIPC-I) + Green Codes (GPCS-I/ GRIHA/ IGBC/ LEED)</i>  | Product must meet a standard recognized or acceptable within the <i>UIPC-I</i> , comply to the provisions of the <i>UIPC-I</i> , and meet green points criteria in <i>GPCS-I</i> and/ or <i>GRIHA</i> and/ or <i>IGBC</i> and/ or <i>LEED</i> . |
|  | Classified WEP-I       | <i>Water Efficient Products – India (WEP-I)</i>  | Product must comply to a national standard or an IS standard, and meet the respective star rating criteria awarded per the 2013 <i>WEP-I</i> specification.   |
|  | Green Classified WEP-I | <i>Water Efficient Products - India (WEP-I) + Green Codes (GPCS-I/ GRIHA/ IGBC/ LEED)</i>  | Same as Classified <i>WEP-I</i> listing criteria above plus product must meet green points criteria in <i>GPCS-I</i> and/ or <i>GRIHA</i> and/ or <i>IGBC</i> and/ or <i>LEED</i> .   |









## Growth of Certified Products

Since the start of IAPMO India's product certification program in 2011, this program has grown to a total of 25 varying product certifications in today's IAPMO India's product listing directory website at [www.iapmoindia.org/Pages/pld.aspx](http://www.iapmoindia.org/Pages/pld.aspx), that include Classified WEP-I,

UIPC-I, UMC-I, USEC-I, and WEP-I/UIPC-I types of IAPMO India product certification.

In addition, there are 11 new certification applications being processed for addition to IAPMO India's product listing directory, which are expected to be consummated in early to middle 2017.

IAPMO India's marks of conformity used for all certification types are:

| Mark  | Listing                | Reference(s)   | Required Criteria  |
|---|------------------------|--|--|
|    | UIPC-I                 | <i>Uniform Illustrated Plumbing Code – India (UIPC-I)</i>  | Product must meet standard recognized or acceptable within the <i>UIPC-I</i> , and comply to the provisions of the <i>UIPC-I</i> .   |
|    | WEP-I & UIPC-I         | <i>Uniform Illustrated Plumbing Code – India (UIPC-I) + Water Efficient Products - India (WEP-I)</i>   | Same as UIPC-I listing criteria above plus product must meet respective star rating criteria per the 2013 WEP-I specification.   |
|  | Green WEP-I & UIPC-I   | <i>Uniform Illustrated Plumbing Code – India (UIPC-I) + Water Efficient Products - India (WEP-I) + Green Codes (GPCS-I/ GRIHA/ IGBC/ LEED)</i> | Same as WEP-I & UIPC-I listing criteria above plus product must meet green points criteria in <i>GPCS-I</i> and/or <i>GRIHA</i> and/or <i>IGBC</i> and/or <i>LEED</i> .  |
|  | Green UIPC-I           | <i>Uniform Illustrated Plumbing Code – India (UIPC-I) + Green Codes (GPCS-I/ GRIHA/ IGBC/ LEED)</i>  | Product must meet a standard recognized or acceptable within the <i>UIPC-I</i> , comply to the provisions of the <i>UIPC-I</i> , and meet green points criteria in <i>GPCS-I</i> and/or <i>GRIHA</i> and/or <i>IGBC</i> and/or <i>LEED</i> . |
|  | Classified WEP-I       | <i>Water Efficient Products – India (WEP-I)</i>  | Product must comply to a national standard or an IS standard, and meet the respective star rating criteria awarded per the 2013 WEP-I specification.   |
|  | Green Classified WEP-I | <i>Water Efficient Products - India (WEP-I) + Green Codes (GPCS-I/ GRIHA/ IGBC/ LEED)</i>  | Same as Classified WEP-I listing criteria above plus product must meet green points criteria in <i>GPCS-I</i> and/or <i>GRIHA</i> and/or <i>IGBC</i> and/or <i>LEED</i> .  |
|  | UMC-I                  | <i>Uniform Mechanical Code – India (UMC-I)</i>   | Product must meet a standard recognized or acceptable within the <i>UMC-I</i> , and comply to provisions of the <i>UMC-I</i> .   |
|  | USEC-I                 | <i>Uniform Solar Energy Code – India (USEC-I)</i>  | Product must meet a standard recognized or acceptable within the <i>USEC-I</i> , and comply to the provisions of the <i>USEC-I</i> .   |
|  | USPC-I                 | <i>Uniform Swimming Pool Code – India (USPC-I)</i>   | Product must meet a standard recognized or acceptable within the <i>USPC-I</i> , and comply to the provisions of the <i>USPC-I</i> .   |

Recently, IAPMO India received inquiries from some plastic pipe and fittings manufacturers regarding the UIPC-I certifications of CPVC and uPVC products along with their respective solvent cements. One such major manufacturer has their plastic pipe and fittings undergoing

current laboratory testing for UIPC-I certification in addition to NSF 61 certification of their plastic products that convey drinking water. IAPMO India's newly formed NSF 61 / UIPC-I mark of conformity is:

| Mark  | Listing         | Reference(s)   | Required Criteria   |
|---|-----------------|--|---|
|  | NSF 61 & UIPC-I | <i>Uniform Illustrated Plumbing Code – India (UIPC-I) + NSF 61</i> | Product must meet a standard recognized or acceptable within the <i>UIPC-I</i> , comply to the provisions of the <i>UIPC-I</i> , and comply to the requirements in standard NSF 61. |

**Recognized Testing Laboratories**

Products intended for certification are required to undergo testing at an IAPMO-recognized test laboratory, such as at the CIPET Laboratory (Hyderabad, India), or one of IAPMO R&T's Laboratories (China, or USA), or by a manufacturer at their IAPMO India-recognized in-house test laboratory. This latter program is known as IAPMO India's "Manufacturer's In-House Test Lab Recognition Program" that gives manufacturers an option to test their own products for subsequent product certification. The feedback from manufacturers regarding this program continues to be positive as more manufacturers welcome this opportunity, which helps them save a lot of time to test their products which also helps reduce the overall time to market of their products. To date, seven different manufacturers' in-house laboratories have successfully undergone audits to standard ISO/IEC 17025, "General Requirements for The Competence of Testing and Calibration Laboratories," and have earned IAPMO India recognition for the testing of their products.

**Outlook**

Based on past and recent interest and inquiries from manufacturers, growth of new product certifications will continue along with recognition of new manufacturers' in-house test laboratories, all of which confirm enhanced contributions and support from various manufacturers for production growth of highest-quality certified products and especially that of enhanced sustainable water conservation products. These efforts also will help to enhance and strengthen society's health, safety and welfare whereby this increased awareness for production of more *UIPC-I* certified products and especially water-efficient conserving products which are one of the main

reasons that IAPMO's upper management approved implementation of IAPMO India's 'UIPC-I / Classified WEP-I / GREEN product certification programs as aforementioned.

The use of these sustainable certified products will help to promote and to heighten efficient water conservation efforts and measures throughout India and around the world. Because of IAPMO India's certification programs, many architects, consumers, contractors, engineers, plumbing instructors, plumbing designers, and inspectors alike continue to be assured that these certified products comply with every standard and code governing their use throughout India.

Now that you see where IAPMO India started and its progress made to date of our product certification services, we kindly ask for your trust and opportunities to serve your entire product testing and certification needs, as we're continually thinking of new ways to further enhance our services to serve you much more and better. There's never been a better time than today to join IAPMO India's directory of certified products ([www.iapmoindia.org/Pages/pld.aspx](http://www.iapmoindia.org/Pages/pld.aspx)) and begin marketing your products within India's rapidly emerging market via IAPMO India's in-house product testing and certification programs. The installation and use of IAPMO India-certified products help give all societies a greater level of assurance and confidence, which also help to protect and optimize the public's health, welfare, and safety, as compared to the general uncertainties that exist in the use of uncertified products. Please peruse IAPMO India's web site and its product certification programs at [www.iapmoindia.org](http://www.iapmoindia.org) and let us know how we may help you to better market your products.

# SOUTH AFRICA

Collaborative design and installation of communal toilet and water supply units across township settlement.



UN Sustainable Development Goals



March 11, every year... everywhere  
www.worldplumbingday.org



# U.S.A.

World Plumbing Day promotion, celebration and school outreach.

# INDONESIA

“ People can clearly see the scale of what we have achieved, and how our citizens are becoming more responsible for their communal toilet facilities. ”

PROJECT HOST, COMMUNITY PLUMBING CHALLENGE 2016: DIEPSLOOT, SOUTH AFRICA.



Corporate Social Responsibility promoting health, safety and the environment.

# GET INVOLVED

Help increase the impact of our ongoing initiatives, Community Plumbing Challenges, and future programs.

1.844.497.4674

IWSH.org

info@iwsh.org





# Swathi Saralaya

Manager – Technical and Training

**T**he boom in infrastructure and real estate, and projects such as Skill India, Swacch Bharat, has necessitated the need for trained plumbing professionals in India. Such trainings in IAPMO India are imparted through Plumbing Education to Employment Programme (PEEP) in private and government vocational training centers.

IAPMO India-and IPA-recognized training institutes such as Sulabh International Centre For Action Sociology (SICAS), Dnyanada Institute Of Flow Piping Technology (DIFPT) and Kohler Plumbing Academy (KPA) have been training plumbers through CSR funds for skill development. C.V.Raman College of Engineering (CVRCE), Bhubaneshwar has trained fresh engineering graduates in Plumbing System Design.

Since 2013, IAPMO India has taken up plumbing training programmes for higher secondary class students in the state of Kerala under Acquired Skill Acquisition Programme (ASAP), a government of Kerala project. Three hundred ninety-six students enrolled for assistant plumber programmes through ASAP's 13 skill development centers and 287 candidates successfully completed the training and were certified by ASAP, IAPMO India and Indian Plumbing Association (IPA). In the subsequent years, the enrolled student count rose to 800 in 30 skill development centers.

Though the challenges are many in skill training in plumbing, joint efforts from ASAP, IAPMO India and IPA as industry partners are being made to promote plumbing as an integral part of public health and to treat plumbing as a noble profession. Community Plumbing Challenge is one such venture by the International Water, Sanitation and Hygiene Foundation (IWSH).

IWSH is a charitable foundation by The IAPMO Group, whose mission is to work to improve on the human condition by fostering the basic human right of safe access to clean water and sanitation. Through this venture people in India have witnessed skilled workforce from various parts of the world. The importance of plumbing in preventing various communicable diseases, to access good quality water supply and sanitation is not taken for granted anymore.

There is a huge amount of work to be done to refine the skill development process in the coming years and I am confident that efforts such as above will soon help develop good plumbing professionals.



## Women Engineers' Conference and Network – WECaN 2016



The Conference FOR WOMEN and BY WOMEN was organized by a volunteer group of women engineers from both academia and construction industry. The intent of the conference was to bring about greater awareness and to highlight the contributions of women engineers in all spheres of construction.

It was attended by more than 200 construction professionals. There were interesting technical talks and panel discussions concerning women engineers in the construction industry by eminent Professionals from the industry. Ms. Neeta Sharma, MD, of IAPMO India participated in the conference and gave a presentation on "Importance of Services in Construction Industry," which was well-received and appreciated by all.



IAPMO India participated in the 21st Indian Plumbing Conference in Jaipur. Propagating plumbing codes and standards, code based training and education, product testing and certification were the key focus. IAPMO India representatives also spoke on the subjects of “Plumbing Education In India–Myth or Reality” and “Water Conservation through Good Plumbing Practices” during the event.



The TERI, GRIHA Council organized the seventh GRIHA Summit in New Delhi with support from the Ministry of New and Renewable Energy, addressing specific issues of concern in the field of sustainability. Ms. Neeta Sharma, MD, IAPMO India, attended the Summit and gave a technical presentation on “Water Distress in Growing Cities – Issues & Challenges.”

## International Seminar on “Emerging Building Materials and Construction Technologies”



In order to take stock of the various innovations and advancements in the areas of building materials, technologies and construction practices, the Building Materials & Technology Promotion Council, Ministry of Housing & Urban Poverty Alleviation, Government of India organized an International Seminar on “Emerging Building Materials and Construction Technologies.”

The international seminar aimed to bring engineers, architects, technology providers, plant and machinery manufacturers, users, government agencies and other stakeholders, looking for emerging building materials and technologies and construction practices on one platform to bring awareness and share the knowledge and experience on new emerging building materials and practices. The seminar, under various sub-themes, had detailed discussions and each session was addressed by the eminent key experts working in that area. Ms. Neeta Sharma participated as a speaker and gave a presentation on “Innovation in Plumbing and Sanitary Services” at the conference.

## Green Building Congress 2016

To further advance the green building movement in India, the Indian Green Building Council (IGBC) organized India's flagship event on green buildings, Green Building Congress 2016 from Oct. 6 to 8, 2016 at Mumbai, India. Sr. Vice President of International Development Megan Lehtonen discussed "Water Efficient Fixtures in Green Buildings" during the event.



IAPMO India staff Swathi Saralaya (Manager – Technical & Training), Neeta Sharma (Managing Director), and Anjali Singh (BDM, far right), with Sr. Vice President of International Business Development, Megan Lehtonen, at the event.



The boom in infrastructure and the real estate sector has created the need for trained plumbing professionals. Skill Gap studies conducted by NSDC reveal that just 0.5 percent of the plumbers working in the country are properly trained. With the growing demand in the construction sector, it is estimated that approximately 12 Lakh plumbers are required in the country by 2020. Construction with the plumbing industry has reiterated the need to have a structured industry training program for the plumbers as most of the existing plumbers are either untrained or self-trained.



With this in mind, the government of Kerala has designed a strategy to tackle the curse of educated unemployment through the State Skill Development Project (SSDP). Within the short of span of its operation, Additional Skills Acquisition Programme (ASAP), which is part of the SSDP, has been successful in ensuring industry participation in the implementation of skill programmes and has received wide acceptance among the student fraternity.



IAPMO India recently signed an agreement with the Indian Plumbing Sector Skill Council (IPSC) for executing skill development programmes in the plumbing sector for ASAP. Skill Development Centers spread across various districts of Kerala have been recognized by the government of Kerala, where basic infrastructure support required for the training is provided.



IAPMO India has taken up the plumbing programmes since the year 2013 and offered them to students studying in Higher Secondary Class. Three hundred ninety-six students enrolled for the Assistant Plumber programme through its 13 skill development centers and 287 candidates successfully completed the training. In the subsequent years, the enrolled student count rose to 804 and 824, respectively.



The assistant plumber course, jointly developed by ASAP and IAPMO India, is a foundation programme in plumbing to provide individuals with basic plumbing skills. Through this course of study, an individual will learn practical aspects of the installation, repair and maintenance of a variety of piping systems, plumbing fixtures and other equipment generally associated with water distribution and wastewater disposal. Students also will be introduced to some of the basic principles and code requirements of typical plumbing systems.

This course equips the students with knowledge in topics including Introduction to Plumbing, Building Sewer (External), Drainage, Waste and Vent (Internal), Occupational Health and Safety, Water Supply (Internal), Engineering Drawing, plumbing Fixtures, *Uniform Illustrated Plumbing Code-India* and Introduction to Plumbing Systems.

## Additional Skill Aquisition Programme

The assistant plumber course curriculum consists of 41 hours of theory, 109 hours of practical and 150 hours of internship, and is compliant to National Occupational Standards of "Plumbing General Assistant" Job role (QP No. PSC/ Q 0102 NSQF Level: 2) of Indian Plumbing Skill Council (IPSC).

The first batch of students who had completed their 150 hours of training and qualified as Assistant Plumbers were felicitated by officials of ASAP and the Advisory Board of ASAP, which consists of IPA members. It was an important moment for the students as 82 of them had been recruited by M/S Sobha Developers. Mr. Ramachandran, IPA, also gave a motivational talk to these young students.



Placement Orientation Programme of Plumbing Sector. 82 students got placement at Sobha Projects Pvt Ltd and Offer letters were distributed by Shri P Ramachandran (Chairman Business Advisory Committee - Plumbing Sector, Ex- Chairman - IPA - Kerala Chapter) and Dr.Reju M.T IAS, CEO ASAP.



Placement Orientation Programme Plumbing Sector



As a part of Convocation for the year 2016, held on October 27, 2016, Skill Expo was organized by ASAP and envisaged to be organized in coordination with IAPMO India as a training partners, as well as the students IAPMO India have trained in the previous years.

A mock lab was set in the space provided, to showcase the skill gained by students we have trained. This event was considered a great platform to showcase the quality training done by IAPMO India, brand the plumbing sector, and in turn send out the message of taking skill development seriously. This was a platform for us to introduce the "Assistant Plumber" course to next year's Summer Skill Skool targeted Students.



## PSD at C V Raman College of Engineering



IPA, IAPMO India and CV Raman College of Engineering (CVRCE), Bhubaneswar entered into an agreement for Plumbing Systems Design (PSD) course under Plumbing Education to Employment Programme (PEEP). The Memorandum of Understanding (MoU) was signed on Jan. 19, 2016 by Neeta Sharma of IAPMO India, Mr. Sanjib Kumar Rout, Chairman and Dr. BK Rath, HOD (Civil) of CVRCE.

### **Dr. BK Rath, Neeta Sharma and Sanjib Kumar Rout after signing the MoU.**

The Plumbing Education to Employment Programme (PEEP), jointly developed by IAPMO India and IPA, prepares multiple levels of professional groups in India to read, understand, interpret, engage and apply the provisions of the *Uniform Illustrated Plumbing Code-India (UIPC-I)* to plumbing systems. Plumbing systems are one of the most important and vital parts of an overall building design. Through this course of study, a student will gain understanding of the principles and code requirements of plumbing system designs and develop the ability to design and review code-based plumbing systems. Students having a diploma or degree in civil engineering qualify for the PSD course.

CVRCE is an autonomous engineering and management institution in the Eastern Zone of Odisha, which was established in 1997 under C.V. Raman Group of Institution. CVRCE is ranked 74th in the National level by MHRD, Govt. of India this year. The college has been at the forefront by having an excellent interface with various industries across the globe through its good numbers of "Centre of Excellence" by providing them personnel for both workforce and executives trained as per their specific requirements and also by imparting training to their employees in a regular basis.

CVRCE is in the process of establishing a state-of-the-art plumbing laboratory in the "Centre of Excellence-Plumbing" with the help of IPA. The lab will be supplemented by world class plumbing modules procured from industries globally acclaimed as the pioneers in manufacturing the education and training tools in plumbing. Work at the plumbing lab is progressing at a good pace and will be completed before the next academic year.

The first batch of 29 students studying B. Tech (Civil Engineering) in CVRCE has successfully completed the Plumbing System Design (PSD), a two-semester course conducted by IAPMO India.

These students have undergone the rigors of the requirements, like more than 100 hours of classroom training including understanding the requirements of UIPC-I.

Further, the students have attended a site visit, submitted six assignments, and prepared a comprehensive project report on plumbing during their program. The program qualifies them to deliver the job of a plumbing engineer

in design, supervision and management of various plumbing activities, the most requisite element in developing the multi complexes (high rises, complex structures, institutions or large colonies) and in manufacturing units of plumbing materials, fixtures and fittings.

These promising, young, PSD-qualified students will be completing their graduation in civil engineering in summer 2017. At this stage they are looking for career and job opportunities. The students need encouragement. Professionals in the plumbing trade are requested to offer them internships or employment and a meaningful exposure to this significant field.



The first batch of PSD students with Sanjib Kumar Rout, Sasanko Sekhar Mohanty and Subhash Deshpande.



A group of 29 students with the faculty.



Subhash Deshpande during training session at CVRCE.

*Interview of Ms. Neeta Sharma, Managing Director, IAPMO India on the National Skills Network (NSN) website. <http://www.nationalskillsnetwork.in/iapmo-india-plumbing/>*

### How IAPMO India is ensuring health, hygiene and sanitation standards in India through plumbing codes

*By Madhuri Dubey on March 28, 2016  
Skill Story, Training Partners*

Codes and standards play an important role in plumbing. As the science and technology of plumbing undergoes tremendous changes, international codes ensure quality and safety through mandatory implementation. In this Skill Story, Neeta Sharma, Director, International Association of Plumbing and Mechanical Officials (IAPMO-India), tells us how the organization is committed to imparting code-based education and training in plumbing, besides publications, events and audits toward reaching their goal of health and social welfare.



#### **IAPMO's Codes and Standards**

We are a part of IAPMO Group that makes codes and standards for plumbing across the globe. These standards and codes are adapted by IAPMO India to suit our geography, our water quality, sanitation, construction, safety etc. It is mandatory to implement the codes, whether it is for the plumbing products or the workforce

in this profession. We partner with the Indian Plumbing Association (IPA) to establish a model code of plumbing installation and maintenance for India.

Based on the codes, we derive educational programs for all levels of professionals – engineers, architects, contractors, supervisors, plumbers and technicians. We align with IPA for creating our programs and together, we are the the apex association representing the industry – with 20 chapters and more than 2000 members.

We started in India in 2007 by formulating the *Uniform Plumbing Code (UPC)* for India, vetted by the industry and converted into the Indian code to suit Indian scenario. Through the codes, we provide the best practices and illustrations to go with it. It covers all the requirements of plumbing – especially the do's and don'ts. For example, in countries like the USA, it is mandatory for any plumber to get certified and upskilled. Hence, the codes are revised every three years, taking into consideration the innovative materials and practices, and the professionals have to get certified accordingly. In India, we are into the third revision of our codes.

#### **Education and Training**

We have several courses under Plumbing Education to Employment Program (PEEP). These include Plumbing Construction Management (PCM), Plumbing System Design (PSD), Plumbing Technology Program (PTM) and Plumbing Apprentice Program (PAP) for addressing the learning needs of the entire plumbing value chain.

We invite universities and institutions to partner with us and take the training program forward in their own way. The minimum duration is 150 hours that includes theory, practicals and assessments. It could either be a crash course in summer, or it could be integrated with some semester. The students take the program as a specialized subject and by the time they come out in the job market, they have vocational certificate and industry experience. We also align with the QPs and NOS of the Plumbing Sector Skill council (IPSSC) in matching the expecting outcomes from each course. This includes vocational education and employability enhancement.



## Interview with Neeta Sharma

We partnered with the government of Kerala for the Additional Skill Acquisition Program (ASAP), funded by ADB and conducted by the Department of Education to train the high school students in vocational skills. Under the employability enhancement scheme, these programs are conducted in 14 districts of Kerala, equipped with industry standards labs and infrastructure. The ASAP program helps them go for higher studies or get into self-employment. The earning potential ranges from Rs.7000 to Rs.14000 depending on their skills and performance.

Plumbing has a tremendous scope for career progression. A junior plumber, after certain years of experience, can become a master plumber and reach the level of a contractor. There is a dire need for trained plumbers, provided they are able to migrate to different places.

We are planning to offer our code-based programs in Odisha, where most plumbers come from. It is important to train and skill them, so that they know the implications of wrong processes and the benefits of doing things scientifically. The biggest challenge is to mobilize students for skill development. Teaching them in English is a challenge. So, we work with trainers who can deliver the programs in their own languages. We give them a complete training program, which includes soft skills, ethics and computer skills.

### Driving Standards and Quality

Prevention is better than cure! Sub standard plumbing has a lot of impact on the health of the occupant. There are cases where poor plumbing practices have led to a lot of diseases and health issues. Through our programs they will be introduced to new concepts, new materials, why certain things should not be used; this makes it scientific and improves the quality of their work. Our water-efficient products are designed using the unique standards of IAPMO and IPA. This gives star rating for water appliances and how plumbing design can be tweaked to achieve these efficiencies. Our goal is to reduce maintenance costs and health risks by solving leakage and corrosion problems.

### Industry Adoption of Codes and Standards

In India, it is still not mandatory for a client

or contractor to use third-party-certified material in plumbing. The industry needs to vet the materials and see if they can be used in a project. They should have proper testing facilities to proactively assess the performance depending on the type of construction water quality and the geographical requirements.

The construction industry is rapidly transforming, and the requirements have changed tremendously. Earlier there were mostly two-story or three to four-story houses. Then, came the proliferation of multistory buildings and then multi-occupancy buildings. In such structures, the dynamics of water changes completely. For example, when 10 flushes are used at the same time, can you imagine the amount of water going down the drain. If the joints are not made properly in the innumerable pipes, so that there's no turbulence in the pipe, there's no leakage. These are the technical standards that are introduced through our codes and industry best practices. We are sure we will be making a huge difference to the plumbing industry and people at large.



*"Even the best of the construction and interiors suffer a lot with poor plumbing installations. Proactive compliance with codes saves a lot of avoidable expense on repair and rework, and reduces wastage. Our codes are scientific and evolve with the developments in technology. Plumbers rise on the job depending on their skill levels and perfection, example how they cut a pipe, or fit the nuts and bolts."*

Neeta Sharma  
Managing Director, IAPMO India



## 22nd India Plumbing Conference, Kolkata

The 22nd IPC was held in Milan Mela in the city of Joy Kolkata, with a central theme "Sustainable plumbing for a healthy society." It was attended by all stakeholders in the construction industry – developers, architects, consultants, contractors, manufacturers, dealers and end users.

*Ms. Megan Lehtonen, Senior Vice President of International Business Development for IAPMO, during panel discussion "Skill Development – The need of the hour."*



*Jonathan Ward, Principal Commercial Officer of U.S. Consulate General Kolkata, Anjali Singh of IAPMO India and Senior Vice President of International Business Development. Megan Lehtonen attend the 22nd Indian Plumbing Conference (IPC)*



**US India Commerce @USCSIndia · 3h**  
 @IAPMO works with the India Plumbing Assn on standards development. @USCSIndia w/VP Lehtonen at IPA Conference @IPA\_Kolkata #IPA2016 #IPC



## IAPMO India recognizes CIPET Hyderabad laboratory as one of the listed laboratories in India to carry out testing

Central Institute of Plastics Engineering & Technology (CIPET) was established in 1968 by the government of India with the assistance of United Nations Development Programme (UNDP) at Chennai. Today CIPET is a premier national institution under the aegis of the Ministry of Chemicals & Fertilizers of the government of India, and is fully devoted to Skill Development, Technology Support Services, Academic and Research (STAR). CIPET operates on hub & spokes model with 28 locations - 5 High Learning Centres, 12 Other Learning Centres, three Specialized Centres, two R & D Wings, five Vocational Training Centre, one Petrochemical Data Services spread across the country catering to the needs of Polymer and allied industries. Eleven more centres are in the process of establishment.



*Mr. V. Kiran Kumar, Director & Head, CIPET – Hyderabad Laboratory along with his team and IAPMO India's MD, Ms. Neeta Sharma and Dr. Abdul Matheen*

CIPET stands tall not only as a premier institute in the country but also has emerged as a global institution renowned for its research and development in the niche areas of polymer science and technology and high-quality education and skill development in the field of plastics. CIPET has been accredited with ISO 9001:2008 QMS, ISO/IEC - 17025, ISO/IEC - 17020 certification.

Headquartered in Chennai, CIPET has centres at Ahmedabad, Amritsar, Aurangabad, Baddi, Balasore, Bhopal, Bhubaneswar, Chennai, Gurgaon, Guwahati, Gwalior, Hyderabad, Hajipur, Haldia, Imphal, Jaipur, Kochi, Lucknow, Madurai, Murthal, Mysore, Raipur, Valsad and Vijayawada. All the state-of-the-art centers are equipped with excellent infrastructure facilities in the areas of Design, CAD/CAM/CAE, Tooling & Mould Manufacturing, Plastics processing, Testing and Quality Assurance with plan fund support from Government of India. The infrastructure facilities in terms of machinery, equipments and technology are continuously upgraded and modernized in tune with needs of plastics & allied industries.

CIPET renders technology support service in the areas of design, tooling, plastics processing and testing and quality assurance in India and abroad. CIPET has been in the forefront of strengthening the technological capabilities and has been constantly building capacities and leveraging its expertise, calibre and skill sets to meet the emerging and evolving needs of the industries. CIPET works in close liaison with industries to implement its initiatives in the areas of polymer and allied industries in accordance with the environmental policies of the country. CIPET's sustained efforts in creating awareness on environmental issues toward plastics and plastics waste management has been very well received by the industry. CIPET Hyderabad is one of IAPMO India's recognized laboratories in India.

## 2016 Continuous Compliance Annual Inspector Meeting



Hands-On Training at IAPMO R&T – IAPMO HEADQUARTERS – West, Ontario, California – USA.

Standards covered during the training:

1. Training on standards NSF 61 (NSF 61: (Sections 3-9)
2. NSF 372 (Sections 3-7)
3. ASTM standards for testing different products/plastic piping & fittings materials such as PVC, CPVC, ABS,
  - ASTM-F438, CPVC Sch 40 Pipe Fittings
  - F438, CPVC Sch. 40 Pipe Fittings
  - F439, CPVC Sch. 80 Pipe Fittings
  - F441, CPVC Sch. 40 & 80 Pipe
  - D1785, PVC Sch. 40 & 80 Pipe
  - D2466, PVC Sch. 40 Pipe Fittings
  - D2661, ABS Sch. 40 Plastic DWV Pipe & Fittings
  - D2665, PVC Plastic DWV Pipe & Fittings
  - D2846, CPVC Pipe & Fittings
  - ASSE 1002-15, Anti-Siphon Fill Valves for Water Closet Tanks,
  - PS 50-10, Dual Flush Device
  - ASME A112.19.5-11, Flush valves





## UMC – I 2017 Review at IAPMO India – Bangalore Office



## Surveillance Audit & Plant Inspection at manufacturing facilities



## Federal Skills Academy

Federal Bank started a pilot skill development academy in Kochi to impart highly demanding courses like Mechanical-HVAC System Design and Plumbing System Design & Technology courses, in partnership with IAPMO India, to meritorious students. Through this initiative, the bank becomes part of the Skill Development Mission initiated by the government of India to upskill millions of students and make India a hub for skilled workforce. IAPMO India in partnership with SB Global Education Resources Pvt. Ltd. They have successfully implemented the goal of skill development set by the Federal Bank by conducting series of six batches of graduate training programs named as Mechanical System Design to the engineering graduate students looking out for a job in the allied industry.



### **Placement Drive:**

Forty-five MEEP MSD candidates from Federal Skills Academy got selected for various positions in Blue Star Limited's Conquer Cooling Solutions Pvt. Ltd. succeeding the interview scheduled at the company office at Bangalore. All of them reported to work April 4, 2016.

### **Federal Skills Academy Launched Mechanical Technicians Training Program**

FSA has launched its second level of training programs in partnership with SB Global Education Resources Pvt. Ltd. keeping in mind the short supply of trained technicians in a rapidly growing mechanical HVAC-R industry, FSA has plans to train more than 500 MTP qualified Mechanical Technicians in 2017, for which IAPMO India is the knowledge partner.



## MEEP for Knowledge Institute of Technology

Knowledge Institute of Technology [KIOT] and IAPMO India have signed a memorandum of understanding for dissemination of Mechanical Education to Employment Programs to their engineering graduates. Faculty from KIOT have participated in faculty training program conducted by IAPMO India. Seen in the picture are the faculty of KIOT receiving the Master Trainers certificate in the hands of IAPMO India Managing Director Neeta Sharma at IAPMO India Bangalore office.



*Dr. Visagavel Kolandaivel, Vice Principal, Knowledge Institute of Technology*



*Dr. H. Abdul Zubar, Associate Professor of Mechanical Engineering, Knowledge*



## IAPMO India Design Lab Inauguration – KIOT



Left picture: Inauguration of the Training Center by the hand of Ms. Neeta Sharma.  
Right picture: Ms. Neeta Sharma addressing the students during Inaugural Session.

## Awareness Programme on Women Empowerment by Neeta Sharma at KIOT





**T**he Sanitation Studio (SS) 2016 is the fourth consecutive studio held in Nepal. Over the duration of the studio, students from Australian universities volunteered their time and skills to develop tools that could be left behind to with the local Nepali teams to help expand and improve the program outcomes. Healthabitat (HH) led the studios in partnership with University of Newcastle (UoN), International Association of Plumbing and Mechanical Officials (IAPMO), WorldSkills (WS) and local Nepali teams. The focus of each studio was to have students work in interdisciplinary teams to produce tangible tools tried and tested on the ground in consultation with the community who would be benefiting from it. This year was the most ambitious of studios, running across three locations with each project at different stages of development. IAPMO India's involvement in the project summarizes as below:

### **Shree Jalapadevi Secondary Higher School, Melamchi**

Jalapadevi is the first school HH has worked with to provide a full sanitation program prior to working with the main village nearby. The aim was to:

- Provide improved sanitation facilities to the 400+ students and staff who access the school daily
- Introduce a teeth-brushing program as part of the school education

## Nepal Sanitation Studio 2016

During the 2014 SS, University of New Castle, University of Sydney and Griffith University students, together with IAPMO managers Swathi Saralaya and Grant Stewart, worked with the school staff to design facilities and planning tools that could be transferred to other school sites. The final design outcome included:

- A new girls toilet block with five toilets and hand washing basin;
- Retrofit of existing toilet block to a boys toilet with four pans, a new urinal and two staff toilets (one later changed to a shower room);
- Separate teeth-brushing bay managed by staff
- Infrastructure works including sourcing water supply
- Removing waste works, including septic tanks and soakage trenches sizes to each block
- Design of a toothbrush storage box for the school

The school and Melamchi region were close to the epicenter of the April earthquakes and therefore experienced complete devastation. HH agreed to continue with the sanitation program. Construction commenced to the girls block after the wet season (September 2015) and was completed by December 2015.

Retrofit of the boys block was underway during this trip. A team of two local plumbers and two plumbers from Community Plumbing Challenge 2015 was led by Bishnu and Swathi.



*Stage 1 – Completed girls toilet block*



# Nepal Sanitation Studio 2016

## Stage 2 activities:

Plumbing works started in the boys toilet area with the combined efforts of Adam Koenings (CPC Team USA), Rob Mauracher (CPC Team AUS), Swathi Saralaya (IAPMO) – all part of Community Plumbing Challenge, Nashik 2015 and local plumbers Lok Tamang and Dorje Tamang. Works included:

- All plumbing works to the boys toilet building including taps, supply, drainage and soak trench installation.
- Brickwork to the septic tank chambers had been installed and some improvements were made to the septic prior to render finishing.
- Hand washing cricket – Game developed during the 2015 CPC in Nashik India was played again to educate on hand washing



The Team



Boys Toilet – Site Photos



# INNOVATION IN PLUMBING AND SANITARY SERVICES

Presentation by Ms. Neeta Sharma at  
International Seminar on Emerging Building  
Materials and Technologies, 2016

The rapid development of the Indian construction industry in the past decades required the plumbing industry, to keep pace with modern plumbing Technology. For this, the codes, standards and practices required improvements to be comparable to international standards. The basic document for plumbing, which can be considered as uniform throughout India, is one part in the National Building Code of the Bureau of Indian Standards, the implementation of which is voluntary until adopted by local statutory bodies.

The first edition of the *Uniform Plumbing Codes*, (UPC), in North America was officially adopted by IAPMO, the International Association of Plumbing and Mechanical Officials, in 1945 based on the recommendations of the committee comprising of all stakeholders. The main reason for such a committee was to mitigate the disorder in the industry, as a result of widely divergent plumbing practices and use of so many different and often conflicting plumbing codes as prevalent then.

With intent to incorporate and implement the latest technology and systems for the protection of public health and hygiene and bring uniformity to the installation of plumbing works, the Indian Plumbing Association (IPA) partnered with IAPMO to prepare Uniform Codes applicable all over India. IPA used, adapted, edited and supplemented the *UPC I- Uniform Illustrated Plumbing Code- India* keeping all basic principles of the original UPC intact but edited to suit the Indian laws and accepted good engineering practices. The *UPC I*, now revised as *UIPC*, with illustrations included, has been designed to provide a lucid and comprehensive technical reference to the citizens of India for safe plumbing practices while as allowing latitude for innovation an introduction to new technology.

*UIPC* attempts to minimize risk by technical standards of design, materials, workmanship and maintenance for plumbing systems. The main aims of the codes are:

- To ensure that planners, designers, installers, administrators and plumbers develop the required competency to ensure that the codes are applied and upheld.
- Those standards are set to ensure that the plumbing assemblies, materials and technologies are safe, effective and latest.
- To ensure that plumbing installations meet these standards.
- To ensure safety and effectiveness continuously through the proper maintenance of these installations.

The code covers on best practices, do's and don'ts, latest materials, their requirements in various chapters as follows:

1. Administration
2. Definitions
3. General Regulations
4. Plumbing Fixtures and Fixture Fittings
5. Water Heaters
6. Water supply and Distribution
7. Sanitary Drainage covering Drainage Systems and Building Sewers
8. Indirect Wastes
9. Vents
10. Traps and Interceptors
11. Storm Drainage
12. Fuel Piping
13. Health Care Facilities and Medical Gas and Vacuum Systems
14. Mandatory Referred Standards
15. Firestop Protection
16. Non- Potable Water Reuse Systems.

The code covers good plumbing practices with introduction to best materials usage. A few practices are listed as below:

- 1. Leakages in Wet Areas**
  - Leakages cause health hazards and also an eyesore.
  - Leakages corrode the reinforcement in structural elements and reduce the life of the building.





First coat of waterproofing



Brickbat filing



Second coat of waterproofing



Plumbing is the first thing blamed for any leakages. Let us look at the activity sequence in a typical toilet.

1. First coat of waterproofing
2. Making holes in walls
3. Laying of under floor drainage pipes and testing
4. Making good the holes in the wall.
5. Brick bat filling
6. Second coat of waterproofing
7. Wall chasing, laying concealed water supply pipes and testing
8. Making good the chases and
9. Wall and floor tiling

Waterproofing, plumbing, masonry/plaster and tiling agencies are involved in the above activities. Even the architects who make toilet layouts and plumbing consultants who specify the materials and items are responsible.

## 1. Causes for leakages

- Making holes in walls or floor and chasing in walls must be done using appropriate tools and equipment. If this is done manually using chisel and hammer, the impact generates cracks in concrete and masonry, ultimately resulting in leakages. The workmanship of pipe joints in masonry or structural member cannot be guaranteed due to restriction of space. There are chances of leakages in masonry or structural member from these joints.
- After the under floor drainage pipes are laid, the brickbat filling starts. Utmost care is essential while unloading the brickbats in the sunken area. It is particularly true for uPVC pipes. The dumping of brickbats can not only disturb the slopes of the pipe, but it can also damage the pipes. In absence of the plumber, the filling work is completed without rectifying the cracked pipes. This is another cause of leakages.
- Leakages are commonly observed where the floors are raised for unplanned toilets. This is mainly because of the different thermal expansion of the concrete slab and raised masonry floor.
- The modern water supply and drainage pipes and joints ensure watertight joints when handled by formally trained plumbers. However, due to non-availability of right fittings, leakages occur. Common example is using "O" ring joints instead of solvent cement joints for horizontal pipes in sunken portion.

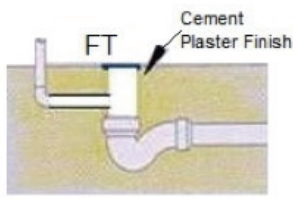

**Don't**

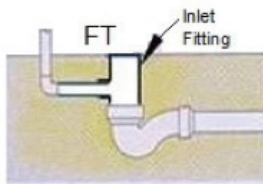

**Do**

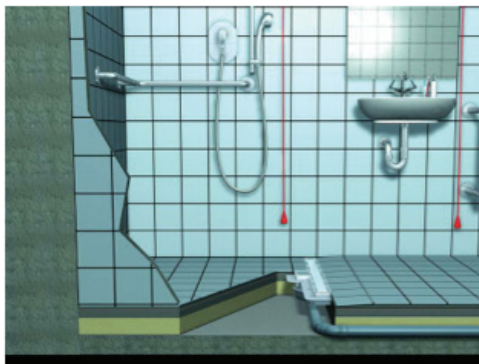

- In case of a high-rise building with gravity water supply, failure of pressure reducing valve (PRV) causes excessive water pressure in the floors below. If the water supply pipes or the joints cannot withstand this pressure, leakages start.
- This connection is done using cement mortar, by a plumber. The workmanship is bad due to limited access and quality is worst due to lack of curing. Water from the floor enters the sunken portion due to capillary action. One good way of making the waste connection is by using an Inlet Fitting, sometime called a Hopper.
- Proper slopes are very important. A diagonal slope towards a floor trap in the corner is easy to draw than to execute. A floor/shower channel solves this difficulty.
- Further, in-situ showers built at site have more chances to leak than shower tray or tub. If the joints between the fixture and wall are not sealed, the accumulated water can result in to leakages.
- Another and major cause of leakages is fast track construction. The floor and wall tiles are fixed before the brickbat filling is truly settled. When it eventually settles along with the floor tiles, the gap between the floor tiles and wall tiles becomes a god place to start leakages. These corner joints shall be filled with rubberised sealants to stop leakage in future.

## 2. Sunken Toilet Floors

It is a common practice in India to "sink" the toilet floors, mainly for three reasons.

- To provide cement based waterproofing.
- To accommodate a floor trap both, for bathing area and water closet.
- To connect the waste pipe from plumbing fixtures and appliances to a floor trap

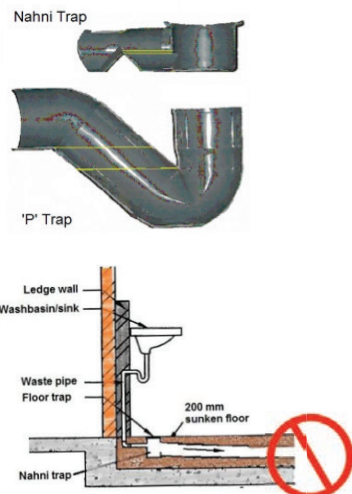

The Indian customs, the floor is sunken by 200 mm so as to accommodate a floor trap, commonly known as a "nahni trap.". Please note that a nahni trap has only 8-10 mm water seal and is therefore not approved by the Uniform Illustrated Plumbing Code-India (UIPC). To accommodate an approved type of floor trap with 50 mm water seal, we need to sunken the toilet floor by 400 mm or preferably 450 mm.

All plumbing fixtures such as a washbasin and kitchen sink are provided with a fixture trap. Such double trapping of a fixture is not recommended by the UIPC.

Drainage pipes are provided below the toilet floor, or in other words, at the ceiling of the toilet below.

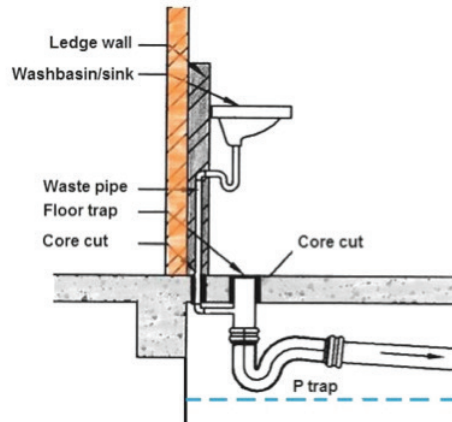

The following comparison will help in selecting the right method.

| Comparison: Initial Cost  |  |
|---|--|
| Sunken Toilet Floors  | Non-sunken Toilet Floors   |
| <ul style="list-style-type: none"> <li>• Cost of 2 coats of waterproofing</li> <li>• Cost of filling</li> <li>• Extra cost of RCC due to additional dead weight</li> <li>• Additional cost of plaster and paint</li> <li>• Additional time for the 4 above</li> <li>• Additional time due to interdependent activities</li> </ul> | <ul style="list-style-type: none"> <li>• Only one coat of chemical waterproofing</li> <li>• Cost saving in filling, RCC, plaster and painting</li> <li>• Extra cost of false ceiling</li> <li>• Extra cost of core cutting</li> <li>• Time saving</li> </ul> |

| Comparison: Cost of Leakage Repairs  |   |
|--|---|
| Sunken Toilet Floors   | Non-sunken Toilet Floors  |
| <ul style="list-style-type: none"> <li>• Need to break plumbing fixtures, tiles, flooring, waterproofing, filling &amp; redo.</li> <li>• Huge cost in repairs</li> <li>• Inconvenience in residential premises</li> <li>• Loss of commercial income @ say Rs. 10,000 per day per room</li> <li>• Time taken &gt; 1 month</li> <li>• Loss of reputation</li> <li>• Damage to RCC and ceiling below</li> <li>• Need cooperation of the owner below.</li> </ul> | <ul style="list-style-type: none"> <li>• No need to break and redo. Just remove part of false ceiling and attend the repairs</li> <li>• Can work at idle hours</li> <li>• Minimum time taken</li> <li>• Negligible cost</li> <li>• No indirect expenses</li> <li>• Good reputation</li> <li>• No damage to RCC</li> <li>• Need cooperation of the owner below.</li> </ul> |

## 3. Traps

**Trap** – A fitting or device so designed and constructed as to provide, when properly vented, a liquid seal that will prevent the back passage of air without materially affecting the flow of sewage or wastewater through it.

*Uniform Plumbing Code-India (UIPC)*

**Tailpiece** – The pipe or tubing that connects the outlet of a plumbing fixture to a trap.

**Trap Arm** – The portion of a fixture drain between a trap and the vent.

**Trap Primer** – A device and system of piping that maintains a water seal in a remote trap.

**Trap Seal** – The vertical distance between the crown weir and the top dip (or upper dip) of the trap.

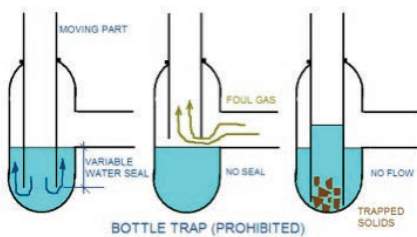
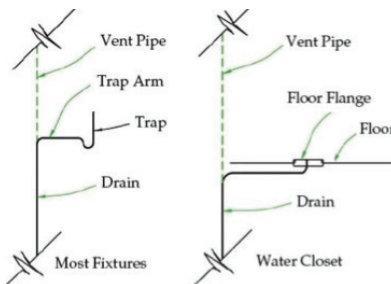
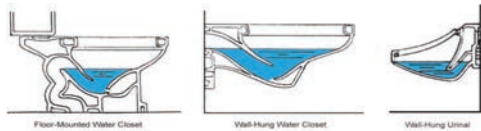
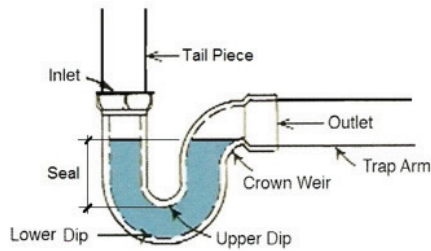

'NAHNI TRAP' (PROHIBITED)

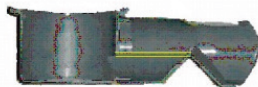

- Each plumbing fixture, except fixtures with an integral trap (see figure below), shall be provided with an approved type water seal trap.
- Each fixture trap shall be protected from back siphonage and back pressure by means of a vent pipe.
- When a trap is filled to the trap seal, the atmospheric pressure at the fixture side shall be equal to the atmospheric pressure at the fixture drain outlet. A pressure variation of plus or minus 1 kg/cm<sup>2</sup> is sufficient to cause a trap to lose its seal. A positive pressure will cause the trap to blow its contents into the fixture, and a negative pressure will siphon the trap seal into its drain. The correctly sized fixture trap vent equalizes the pressure on the outlet and inlet side of the trap.

### Prohibited traps:

- No form of trap that depends for its seal upon action of movable parts shall be used.
- No trap that has concealed interior partitions, except those of plastic, glass, or similar corrosion-resisting material, shall be used.
- "S" traps and crown-vented traps shall be prohibited.
- Bottle traps, "nahni traps" are prohibited.
- No fixture shall be double trapped.
- Drum and bottle traps shall be installed only when permitted by the Authority Having Jurisdiction for special conditions.
- No trap shall be installed without a vent, except as provided in this code.



While installing the fixture traps, remember to follow the restrictions on the developed length and diameter of the tail piece and trap arm, as specified in *UIPC*.

- A liquid seal of not less than 50 mm.
- A smooth and uniform interior waterway.
- Self cleansing type.
- ABS, cast brass, cast-iron, PP, PVC, or other approved materials.
- No internal moving parts to make the trap seal.
- Trap partitions of corrosion resistant materials and non-removable.
- Slip joints limited on each trap arm to one slip joint after the P-trap.
- Manufacturer's name stamped.

***Traps with adequate water seal, when properly vented, protects your health.***



#### 4. Vents

According to *UIPC* each plumbing fixture needs a trap, and each trap needs a vent to protect trap seal. This is contrary to the practice in India:

- Most plumbing fixtures are connected to a floor trap.
- The plumbing fixtures may or may not have a dedicated fixture trap.
- Each plumbing fixture and also the floor trap do not have a dedicated vent.
- Proper venting assures trap seal integrity.
- Protection from the entry of sewer gases is afforded by the 50 mm trap seal.
- Vent systems designed as per the *UIPC* maintain pressure variations within 25 mm water column.

#### **Vents required:**

Each plumbing fixture trap shall be protected against siphonage and back-pressure, and air circulation shall be assured throughout all parts of the drainage system by means of vent pipes.

The *UIPC* is unique among the codes because of two phrases, which are not contained in some other codes. The phrases are:

- "the trap shall be protected against back siphonage and back-pressure"
- "air circulation shall be ensured throughout all parts of the drainage system by means of vent pipes"

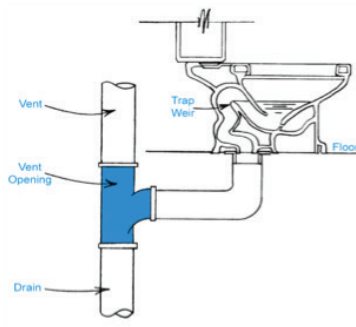

### Functions of Vent:

1. Prevent trap siphonage and blowout. Proper venting assures trap seal integrity
2. Provide an air pathway into and out of the drainage system.
3. Provide oxygen so that anaerobic and aerobic bacteria may keep system from becoming foul (sulfur odor and acidic).
4. Provide venting for onsite and offsite drainage system

### 5. Water Conservation

As water is a finite resource and as consumption keeps rising due to increase in population and modern lifestyle, conservation measures are being adopted across the globe. Largest consumption of water is for agriculture, followed by industries. Water consumption for domestic applications within buildings constitutes approximately 10 percent of the total water consumed. Conservation measures described here are limited only to the domestic water used for human consumption and include use of the following:

- Low flow faucets and showers.
- Dual flush cisterns for water closets consuming no more than average 4 ltr per flush (flush volume of 4 ltrs for dual flush cisterns are calculated as an average of two 3 ltr flush and one 6 ltr flush).
- Sensor operated (electronic) flushing devices for urinals with flush volume of no more than 1 ltr.
- Metered faucets for wash basins in public wash rooms.
- Pressure and flow regulators in faucets and showers.
- Cloth washers and dish washers consuming reduced volume as per WEP-I
- Water meter for monitoring consumption at different zones.
- Alternative water sources (recycled/reclaimed, on site water sources, harvested rain water etc) for non- potable applications such as flushing, landscape irrigation and HVAC makeup water.



Water conservation measures shall also include preservation and protection of existing sources by ensuring that they are not polluted by discharge of untreated waste water, contaminated surface water etc. In order to ensure conservation of water by usage of fixtures and fittings as mentioned above, third party certified products are recommended for usage. Testing and certification programs are currently implemented in India based on *UIPC* and *WEP-I* –publications by IPA and IAPMO-I.

Water conservation measures described above are likely to save up to 30 percent on the cost of water consumed and indirectly the energy consumed.

Existing fixture fittings for private or public use shall be provided with water conserving devices (aerators or flow restrictors) in accordance with the following fixture fittings and maximum flow rates at the maximum permitted working pressure of 5.5 bar. Maximum flush volumes are prescribed in Chapter 4 of *UIPC*. Also refer to 2013 *Green Plumbing Code Supplement-India (GPCS-I)* for conserving water and energy using alternate water resources.



Water Efficient Products-India (WEP-I) is a Rating System for Sustainable Plumbing in India. WEP-I is a set of recommendations to all those who are involved in the design, engineering, manufacturing, selection, installation and maintenance of water efficient plumbing products for domestic and commercial applications in India. The use of WEP-I is intended to encourage use of water efficient products, to incorporate and implement the latest technology and systems and provide uniformity in the performance of products.

Water-efficient labelling system for plumbing fixtures and fittings is universally recognized approach to achieve the objective of water, and energy, conservation in urban domestic and commercial use.

| <b>Star Rating by Water Consumption</b>                   |  |   |   |
|---|--|---|---|
| <b>FIXTURE TYPE</b>                                       | <b>GREEN</b><br> | <b>GREEN</b><br> | <b>GREEN</b><br> |
| <b>Clothes Washers</b>                                    | < 650 L/m <sup>3</sup>   | 535 L/m <sup>3</sup>  | 400 L/m <sup>3</sup>  |
| <b>Dishwashers</b>  | 16 L/Full Load   | 11 L/Full Load  | 6 L/Full Load   |
| <b>Faucets - Handheld Ablution Spray</b>                  | 5.7 Lpm  | 5.0 Lpm   | <b>4.0 Lpm</b>  |
| <b>Faucets (non-metered) - Private</b>                    | 8 Lpm  | 5.7 Lpm   | <b>5.0 Lpm</b>  |
| <b>Faucets (metered) - Public (Electronic/Mechanical)</b> | 1 L/cycle (Mechanical)   | 1 L/cycle (Electronic)  | <b>0.5 L/cycle (Electronic/Mechanical)</b>  |
| <b>Faucets - Sink &amp; Handheld Spray</b>                | 8 Lpm  | 5.7 Lpm   | <b>5.0 Lpm</b>  |
| <b>Shower Heads / Handheld Showers</b>                    | 9.5 Lpm  | 7.5 Lpm   | <b>5.7 Lpm</b>  |
| <b>Urinals</b>  | < 3.8 Lpf  | < 2 Lpf   | <b>&lt;1 Lpf</b>  |
| <b>Water Closets:</b>                                     |  |   |   |
| Combination, Asian/India (Squatting pan)                  | 4.8 Lpf;<br>6 Lpf/3 Lpf  | < 4.8 Lpf   | TBD*  |
| European  | 6 Lpf/3 Lpf  | TBD*  | TBD*  |
| European (High-efficiency)                                | 4.8 Lpf  | < 4.8 Lpf   | <b>&lt; 4.0 Lpf</b>   |



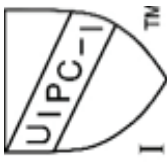
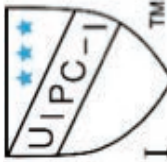

\* To Be Determined

## IAPMO India's Nomenclature for Marks of Conformity



| Mark  | Listing              | Reference(s)   | Required Criteria   | Description  |
|---|----------------------|--|---|--|
|    | UIPC-I               | Uniform Illustrated Plumbing Code – India (UIPC-I)   | Product must meet standard recognized or acceptable within the UIPC-I, and comply to the provisions of the UIPC-I.  | Logo for products that comply to their primary performance standard, recognized or acceptable within the UIPC-I, and also are certified to the UIPC-I.   |
|    | WEP-I & UIPC-I       | Uniform Illustrated Plumbing Code – India (UIPC-I) + Water Efficient Products - India (WEP-I)  | Same as UIPC-I listing criteria above plus product must meet respective star rating criteria per the 2013 WEP-I specification.  | Same as UIPC-I listing description above plus water consumption measurement made per the Standard's procedure, and respective star rating awarded per the 2013 WEP-I specification.  |
|   | Green WEP-I & UIPC-I | Uniform Illustrated Plumbing Code – India (UIPC-I) + Water Efficient Products - India (WEP-I) + Green Codes (GPCS-I/ GRIHA/ IGBC/ LEED, as requested by applicant) | Same as WEP-I & UIPC-I listing criteria above plus product must meet green points criteria in GPCS-I and/or GRIHA and/or IGBC and/or LEED, as requested for evaluation by product certification applicant.  | Same as WEP-I & UIPC-I listing description above plus respective green points awarded by GPCS-I and/or GRIHA and/or IGBC and/or LEED, as requested for evaluation by a product certification applicant.  |
|  | Green UIPC-I         | Uniform Illustrated Plumbing Code – India (UIPC-I) + Green Codes (GPCS-I/ GRIHA/ IGBC/ LEED, as requested by applicant)  | Product must meet a standard recognized or acceptable within the UIPC-I, comply to the provisions of the UIPC-I, and meet green points criteria in GPCS-I and/or GRIHA and/or IGBC and/or LEED, as requested for evaluation by a product certification applicant. | Same as UIPC-I listing description above whereby this green logo is for products that might not consume water but that may still earn green points awarded by GPCS-I and/or GRIHA and/or IGBC and/or LEED, as requested for evaluation by a product certification applicant. |



## IAPMO India's Nomenclature for Marks of Conformity

| Mark  | Listing                | Reference(s)  | Required Criteria  | Description  |
|---|------------------------|---|--|--|
|    | NSF 61 & UIPC-I        | Uniform Illustrated Plumbing Code – India (UIPC-I) + NSF 61 (As requested by applicant)                       | Product must meet a standard recognized or acceptable within the UIPC-I, comply to the provisions of the UIPC-I, and comply to the requirements in NSF 61, as requested for evaluation by a product certification applicant. | Same as UIPC-I listing description above plus NSF 61 certification whereby this combined logo is for products that convey drinking water and comply to the product's primary performance standard, as requested for evaluation by a product certification applicant. |
|    | NSF 61 Only            | NSF 61 Only   | Product must comply to standard NSF 61.  | Logo for products not certified to their primary performance standard nor to UIPC-I but to NSF 61 only.  |
|   | Classified WEP-I       | Water Efficient Products – India (WEP-I)  | Product must comply to a national standard or an IS standard, and meet the respective star rating criteria awarded per the 2013 WEP-I specification.   | Logo for products not UIPC-I certified. Water consumption measurements made per the Standard's (ASME, international, or IS as approved by IAPMO) procedure and respective star rating awarded per the 2013 WEP-I specification.                                      |
|  | Green Classified WEP-I | Water Efficient Products - India (WEP-I) + Green Codes (GPCS-I/ GRIHA/ IGBC/ LEED, as requested by applicant) | Same as Classified WEP-I listing criteria above plus product must meet green points criteria in GPCS-I and/or GRIHA and/or IGBC and/or LEED, as requested for evaluation by a product certification applicant.               | Same as Classified WEP-I listing description above but also include the respective green points awarded by GPCS-I and/or GRIHA and/or IGBC and/or LEED, as requested for evaluation by a product certification applicant.  |

## IAPMO India's Nomenclature for Marks of Conformity

| Mark   | Listing | Reference(s)                                | Required Criteria  | Description   |
|--|---------|---|--|---|
|   | UMC-I   | Uniform Mechanical Code – India (UMC-I)     | Product must meet a standard recognized or acceptable within the UMC-I, and comply to provisions of the UMC-I.       | Logo for products that comply to their primary performance standard, recognized or acceptable within the UMC-I, and also comply to the provisions of the UMC-I.   |
|   | USEC-I  | Uniform Solar Energy Code – India (USEC-I)  | Product must meet a standard recognized or acceptable within the USEC-I, and comply to the provisions of the USEC-I. | Logo for products that comply to their primary performance standard, recognized or acceptable within the USEC-I, and also comply to the provisions of the USEC-I. |
|  | USPC-I  | Uniform Swimming Pool Code – India (USPC-I) | Product must meet a standard recognized or acceptable within the USPC-I, and comply to the provisions of the USPC-I. | Logo for products that comply to their primary performance standard, recognized or acceptable within the USPC-I, and also comply to the provisions of the USPC-I. |

## RMC Capability Certification by IAPMO India

The quality Council of India has approved IAPMO's plumbing codes and standards India Pvt. Ltd, Bangalore for RMCPSC scheme as Certification Body to for RMC Capability Certification. The RMC Plant Certification process begins with submittal of the application form followed by review of application, certification audit and grant of license for RMC Capability Certification. Certified RMC Plants will provide the greatest levels of assurance and confidence to the users, that using the certified plant's concrete will greatly help to protect the public's health and safety, as compared to the feelings of general uncertainties that exist in the use of uncertified plants.

Kindly visit our website [www.iapmoindia.org](http://www.iapmoindia.org) for more information or contact Anjali Singh at [anjali.singh@iapmo.org](mailto:anjali.singh@iapmo.org), T- 08030714500.





[www.iapmoindia.org](http://www.iapmoindia.org)

IAPMO Plumbing Code and Standards India Private Limited  
CIN: U90002KA2007FTC044357  
No. 22, 12th B Main, HAL II Stage,  
Indiranagar  
Bangalore  
Karnataka - 560038 India

Phone: +91 80 30714500

© IAPMO2017